

# HEAT<sup>®</sup> DECOR

## HEAT DECOR HEATING FILM INSTALLATION MANUAL

- UNDER FLOOR PANELS  
**HD-PRO SERIES**

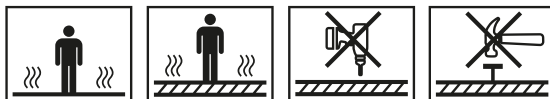

# HEAT DECOR HD-PRO HEATING FILM UNDER FLOOR PANELS

The Heat Decor heating film is intended for the installation of underfloor heating indoors. The HD-PRO series heating film assembly manual is devoted to the principles of installing the heating film under the floating floor coverings such as laminate panels, SPC vinyl panels (without integrated underlay), multi-layer board.

## SPECIFICATION OF HEAT DECOR HEATING FILM HD-PRO SERIES

### PIC. NO. 1.



- 1 COPPER TAPE** acts as a electric current conductor. Electric wires should be conected to the copper tape by the connectors.
- 2 GRAPHITE PASTE** this is the basic material of heating film. The proportion of the graphite paste mixture regulates the power of the heating film.
- 3 SAFE CUT HD** this is the area of the heating film where we can cut it safely.
- 4 HEATING FILM TECHNICAL SPECIFICATION** technical description including information such as: heating film model, heating power, voltage, production date, running meter of a heating film roll.

### HEATING FILM HD-PRO.100, HD-PRO.50, HD-PRO.25

TABLE NO.1

MODEL	FILM WIDTH [cm]	POWER [W/m]	POWER [W/sqm]	VOLTAGE [V]	CUTTING SPOTS [cm]	FILM THICKNESS [mm]	MAX TEMP. OF HEATING FILM [°C]	MAX LENGHT OF ONE STRIPE [m]	MAX POWER OF ONE STRIPE [W]
HD-PRO.100	100	220	220	230	1	0,5	~48	5	1100
HD-PRO.100	100	140	140	230	1	0,5	~38	8	1120
HD-PRO.100	100	80	80	230	1	0,5	~30	12	960
HD-PRO.100	100	60	60	230	1	0,5	~26	14	840
HD-PRO.50	50	110	220	230	1	0,5	~48	10	1100
HD-PRO.50	50	70	140	230	1	0,5	~38	14	980
HD-PRO.50	50	40	80	230	1	0,5	~30	22	880
HD-PRO.50	50	30	60	230	1	0,5	~26	26	780
HD-PRO.25	25	55	220	230	1	0,5	~48	18	990
HD-PRO.25	25	35	140	230	1	0,5	~38	26	910
HD-PRO.25	25	20	80	230	1	0,5	~30	32	640
HD-PRO.25	25	15	60	230	1	0,5	~26	36	540



IPX7

**Thank you for purchasing the Heat Decor heating film. This manual will help you to safely install the Heat Decor heating film and answer questions that may arise during assembly.**

## TABLE OF CONTENTS

<b>SPECIFICATION OF HEAT DECOR HD-EPL FILM</b>	<b>2</b>
Installation materials.	4
Pictures of installation materials.	5
Installation tools, pictures of installation tools.	6
<b>SAFETY</b>	<b>7</b>
What to pay attention to when installing the heating film.	8
Preparations before starting the installation of the heating film.	9
The method of connecting the heating film.	12
Prohibited activities.	13
Diagram of the arrangement of the heating film under the panels.	14
Pictorial diagram of the heating film installation.	15
<b>MANUAL FOR ASSEMBLING THE HD-G HEATING FILM UNDER THE PANELS</b>	<b>16</b>
Installation of the floor temperature sensor.	18
Implementation of floor insulation Heat Decor HD.IS.100 / 5 foam insulation mat.	20
Implementation of the floor insulation, an insulating mat made of Heat Decor HD-XP5300 boards.	21
Arranging the Heat Decor heating film.	21
Preparing the electrical connection of the heating film.	24
Electrical connection with a connector type: Ax.	27
Electrical connection with a connector type: Bx.	28
Electrical insulation of the Heat Decor heating film.	30
Placement of the heating film above the floor temperature sensor.	34
Installation of Heat Decor heating film on an insulating mat.	35
Measurement and test of the Heat Decor heating system.	38
Finishing the installation of the heating film.	40
Draft of heating film installation.	42
Warranty Card.	45

# INSTALLATION MATERIALS

## INSTALLATION MATERIALS

**TAB. NO. 2**

LP	NAZWA	SPECYFIKACJA	ZASTOSOWANIE
1	<b>Heat Decor heating film</b> Model: HD-PRO.100, HD-PRO.50, HD-PRO.25	Width: 100, 50, 25 cm Power: 60 - 220 W/sqm Power supply: 230V, 50Hz	Purpose of HD-EPL series heating film for floor heating for various types of floating panels, based on insulation base:  <b>1. Heat Decor insulation mat HD.IS.100/5 foam:</b> • Laminated panel with min. 6 mm thick.  <b>2. Heat Decor insulation mat made of HD-XPS300 styrodur:</b> • Laminated panel with min. 6 mm thick. • Layered board with min. 10 mm thick. • SPC vinyl panel (without integrated underlay) by min. 4 mm thick.
2	<b>Heat Decor insulating mat - Foam</b> Model: HD.IS.100/5	Thickness: 5mm	Thermal insulation. Protection against cooling and dampness of the floor. Used for floating laminate panels.
3	<b>Heat Decor insulating mat - Styrodur</b> Model: HD-XPS300	Thickness: 6-10mm	Thermal insulation. Protection against cooling and dampness of the floor. Used for floating floors such as panels laminated, layered board, SPC vinyl panel (without integrated underlay).
4	<b>Electric wire double insulated</b> Model: HD-H07VV	Type: Lgy 450/750 V - stranded Diameter: min. 1.5 mm <sup>2</sup>	Electric wire for performing electrical connections double insulated.
5	<b>Installation connector</b> Model: Typ Ax Model: Typ Bx	Tin-coated copper connector. Teeth / tabs on one side of the connector. • Type Ax, straight connection • Type Bx, angular connection	Connecting the electric wire with the heating film.
6	<b>Self-amalgamating tape</b> Model: T.W.C	Butyl tape Width: 50 mm	Insulating electrical connections of the heating film with electric wire. Protection against the moisture and electric breakdown.
7	<b>Self-adhesive tape</b> Model: T.HD	Width: 50mm	Gluing the insulating mat, vapor barrier film, heating film with insulation mat or HD-XPS300 styrodur.
8	<b>Reinforced self-adhesive tape</b> Model: T.HD.Z	Width: 50mm	Gluing HD-XPS300 styrodur insulation board.
9	<b>Electrical insulating tape</b> Model: HD-PRO	Width: 50 mm Length: 15m	Insulating electrical connections of the heating foil, protection against moisture and electrical leakage.
10	<b>Installation box</b>	Dimension: $\varnothing 60/60$ Type: flush/drywall	Installation of the thermostat and electrical connections.
11	<b>Electric protective conduit</b>	Dimension: $\varnothing 16$	Protection of electric wires and floor temperature sensor against mechanical damage.
12	<b>Vapor barrier film</b>	Thickness: min. 0.2 mm	Protection against dampness of the floor and the heating film. Vapor barrier.
13	<b>Thermostat</b>	1. Air temperature sensor 2. Floor temperature sensor 3. Power supply 110 / 230V 4. Max load. 16A	Room air temperature control. Control temperature of the heating film - floor.

# PICTURES OF INSTALLATION MATERIALS



1



2

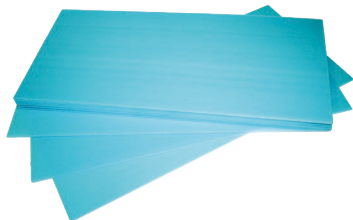

3

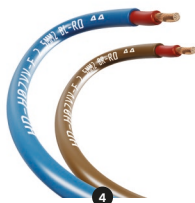

4



5



6



7



8



9



10



11



12



13

# INSTALLATION TOOLS

## INSTALLATION TOOLS

**TABLE NO.3**

NO.	NAME	PURPOSE
1	Multimeter	Voltage [V] & resistance measurement [Ω].
2	Pyrometer	Temperature measurement of the heating film.
3	Crimping Pliers Model: HD-LS.02	Crimping installation connectors, performing electrical connections.
4	Stripping pliers	Stripping the electric wire sheath. Performing connections of electric wires.
5	Scissors	Heating film cutting.
6	Wallpaper snap knife	Insulation mat cutting.
7	Calculator	Calculation of electric power consumption.
8	Screwdriver	Thermostat installation.
9	Measuring tape	Measurement of the installation area.



1



2



3



4



5



6



7



8



9



**⚠ ATTENTION! PLEASE READ THE SAFETY MANUAL CAREFULLY BEFORE USING**

## UNPACKING

After purchasing the product, please check the contents of the package and the technical condition of the Heat Decor heating film. When purchasing a Heat Decor heating film installation set, the package includes:

- Heat Decor heating film
- thermostat with a floor temperature sensor
- protective tube (conduit)
- installation box
- Heat Decor adhesive tape
- connection set type Ax or type Bx
- HD-H07VV double insulated installation wires

## SAFETY

**⚠ ATTENTION! PLEASE READ THE MANUAL FOR USING THE HEATING FILM BEFORE USING THE FILM, AND KEEP THESE MANUAL FOR FUTURE REFERENCE.**

- It is possible to use the heating film by children from 8 years of age, provided that supervision and proper instruction on safe operation are provided.
- Children under eight years old should not play with the thermostat.
- Children are not allowed to perform cleaning and maintenance activities on the equipment without parental supervision. All activities related to the maintenance and cleaning of the equipment must be carried out in a safe manner and with the power off.
- This installation may be operated by people with reduced physical or mental capabilities who have no previous experience with the product, but have received instructional training in how to use the installation in a safe manner.
- If the power cord or the heating film is damaged, the product is not suitable for use and installation and should be disposed of.
- Installation of underfloor heating and Heat Decor heating film in each room must have a separate electric circuit, type B overcurrent switch and differential-current switch. The types of circuit breakers and residual

## SAFETY

current devices are selected by an electrical designer or licensed electrician. The types of circuit breakers and residual current devices are selected by an electrical designer or licensed electrician.

- It is forbidden to install the heating film under the panels in a floating floor system in wet rooms, for example; in a bathroom.

**⚠ ATTENTION! IF THE HEAT DECOR HEATING FILM IS DAMAGED DURING UNPACKING, IT IS FORBIDDEN TO BE INSTALLED AND IT IS RECOMMENDED TO CONTACT THE SELLER.**

### **⚠ WHAT TO PAY ATTENTION TO WHILE INSTALLING?**

1. Any installation work carried out must be performed when the power supply is switched off.
2. Keep the installation site clean. The floor must be flat, free of sharp elements and dents in order to avoid scratches, bends, and other damage to the heating film.
3. The place of installation of the heating film must be dry. Films should be protected against direct access to water/moisture. Do not use the heating foil on a damp substrate.
4. Do not use underlay materials that may damage the heating film (aluminum sheet, steel sheet, etc.).
5. Do not use underlays absorbing moisture (paper, wood, cellulose, etc.).
6. Do not use metalized primers.
7. It is forbidden to use the heating film under the panels in wet rooms such as bathrooms, etc.
8. Do not install the heating film without a temperature regulator (thermostat) equipped with a floor temperature sensor (except for the heating film with a power of 60 W/sqm, to which you can be installed with a thermostat only with an air sensor).
9. The heating film can be supplied only in the installation box, it



## ❗ WHAT TO PAY ATTENTION TO WHILE INSTALLING?

is forbidden to supply the heating film directly from the socket.

**10.** Pay attention not to damage the heating film during installation.

Do not pierce the heating film, do not drill in the heating film.

**11.** It is forbidden to fix the heating foil with nails, screws, bolts, and other metal objects.

**12.** Do not use floor finishes that could become deformed or cracked due to heat transfer.

**13.** If the heating foil installation power exceeds 80% of the maximum load value of a given temperature regulator (thermostat), use a contactor or a second thermostat.

**14.** Electric wires supplying the heating film cannot be installed on the heating film or under the heating film.

**15.** Installation of heating film in the underfloor system must be equipped with a type B overcurrent switch and a residual current device in the electric circuit.

**16.** Insulate the heating film thoroughly with self-amalgamating tape in the places of connectors and copper strips on the other end of the heating film.

**17.** Do not place the heating foil under the permanent furniture which

directly adheres to the ground and prevents it from being free to air flow (fridge, washing machine, chest of drawers). It is allowed to use furniture and devices equipped with legs with a minimum height of 30 mm, enabling the free flow of heat.

**18.** The heating film should have a separate electric power supply and should not be combined with other electrical devices.

**19.** Do not put the heating film overlapping or overlapping.

**20.** Cut the heating film in designated places and insulate the ends of the heating film with self-amalgamating tape.

## ❗ WHAT TO PAY ATTENTION TO WHILE INSTALLING?

- 21.** Start-up of the heating system should be made with the heating film in accordance with the recommendation of the manufacturer of floating floor panels.
- 22.** When laying the top floor covering, be careful not to damage the heating film and the vapor barrier film. It is forbidden to leave any elements (plaster, debris, nails, etc.) on the heating and vapor barrier film, as this may damage the entire heating system.
- 23.** Use the heating system following the recommendations of the manufacturer of floor coverings (recommended by most manufacturers of floor panels maximum used temperature is 28°C).
- 24.** Electrical connections and measurements may only be performed by an electrician with valid licenses.
- 25.** The heating film should be stored in a dry room at room temperature. The maximum number of stacked full rolls of heating film is 2.
- 26.** The installer of the heating film should have shoes with a soft sole during the installation to avoid possible damage to the heating film installation.
- 27.** Apply electrical grounding of structural metal elements such as frames, grates, furniture, doormats within the heating film.
- 28.** It is forbidden to install the heating film at a temperature below 5°C.
- 29.** When performing the installation, observe all dimensions and distances specified in the manual.
- 30.** The instructions, along with the completed warranty card and the precisely prepared design, should be kept for further users and future installation and maintenance works.

## PREPARATIONS BEFORE INSTALLATION HEAT DECOR HEATING FILM

1. Check the compliance of the heating film power with the planned installation. The technical specification of the heating film is located on the edge of the heating film stripe. **(PIC. NO. 1, P. 2).**

2. Check the parameters of the electrical installation in the building to make sure that there will be no issues with the simultaneous use of the heating film and other devices, electric receivers. If the electrical power of the connection is insufficient, it should be increased to the level of safe operation of the electrical installation. The heating film works on an electric voltage of 230V.

3. Check the main electric wires supplying the entire heating film installation. The wires should be dimensioned according to regulations for the electrical load corresponding to the total power of the heating foil installation.

4. Check the humidity on the base on which the heating film will be installed - the humidity of the base must not exceed 2%

5. Check the condition of thermal insulation in the building to decide on the thickness of the insulation used for the heating film and the selection of the appropriate power of the heating film.

6. Sketch the room on the warranty card, including its dimensions. Plan and draw on the warranty card the location of the heating film along with routes of laying

electric wires supplying the heating film. Plan and mark the location of the electrical box and electric wires supplying the heating film. Put all dimensions on the sketch of the heating film installation. A well-prepared sketch will facilitate the assembly.

7. Plan the arrangement of the heating film following the installation conditions of the heating film. The maximum length of the heating film stripe depends on the film power and is shown in the technical table of the product **(TAB. NO. 1, P. 2).**

8. Calculate the planned power of the installed heating film. If the electric power of the installed heating film is greater than the existing connection, the electric power of the connection should be increased

$$P[W] = P_f[W] \times D_f[sqm]$$

**P** - Planned power of the heating film installation.

**P<sub>f</sub>** - Power consumption of the heating film per sqm.

**D<sub>f</sub>** - The surface area of the heating film to be installed on the floor.

9. Adjust the cross-section of the electric wire (cable thickness) connected to the heating film to the power of the heating film to be installed.

**⚠ ATTENTION! THE CHOICE OF THE WIRE DIAMETER FOR THE POWER SUPPLY CIRCUIT SHOULD BE PERFORMED BY A DESIGNER OR ELECTRICIAN WITH A LICENSE!**

**⚠ ATTENTION! PLAN THE LOCATION OF THE THERMOSTAT IN A PLACE WITH NO DIRECT SUN AND DRAFTS EXPOSURE.**

## HEATING FILM CONNECTION METHOD NO. 1

SCHEME NO. 1

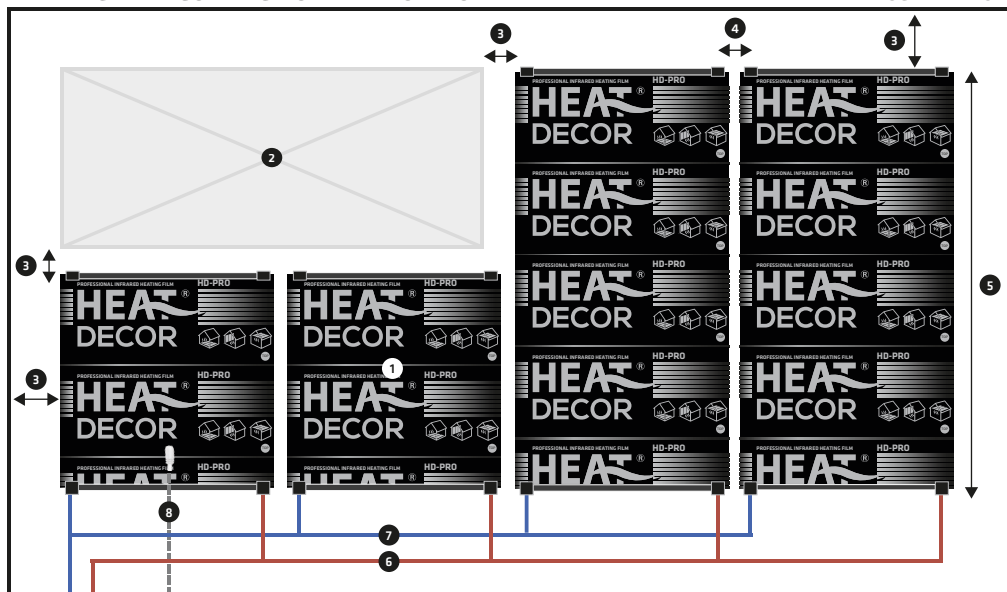

1. Heat Decor heating film
2. Permanent furniture
3. Spacing of min. 5 cm
4. Spacing of 0.5 - 1 cm
5. Maximum length of the heating film stripe  
(TAB. NO. 1, P. 2)

6. Phase Wire [L]
7. Neutral Wire [N]
8. Temperature sensor
9. Thermostat

**HEATING FILM CONNECTION METHOD NO. 2**

**SCHEME NO. 2**

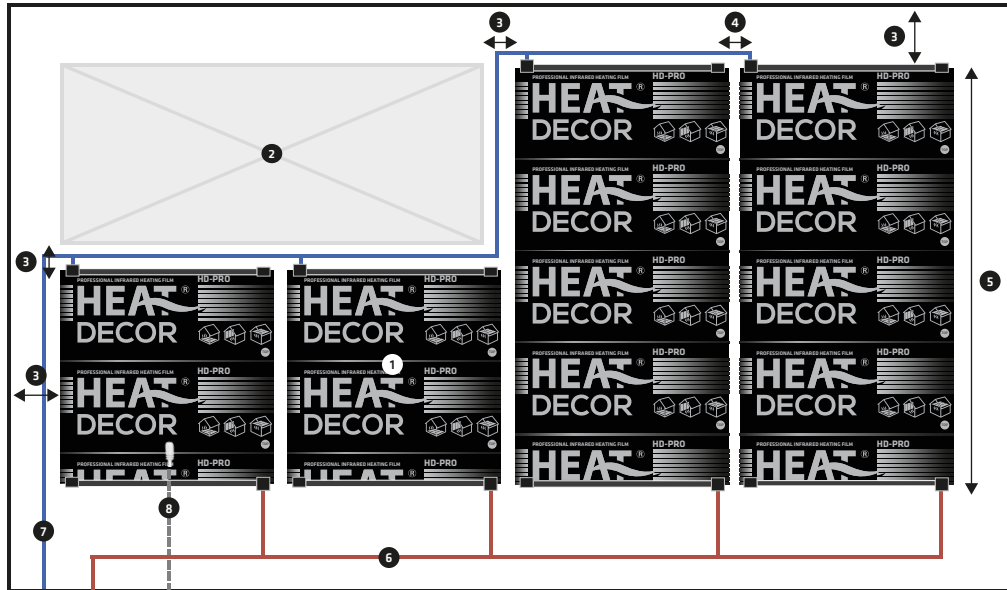

- 1. Heat Decor heating film
- 2. Permanent furniture
- 3. Spacing of min. 5 cm
- 4. Spacing of 0.5 - 1 cm
- 5. Maximum length of the heating film stripe (TAB. NO. 1, P. 2)
- 6. Phase Wire [L]
- 7. Neutral Wire [N]
- 8. Temperature sensor
- 9. Thermostat

**! ATTENTION! PROHIBITED ACTIONS!**

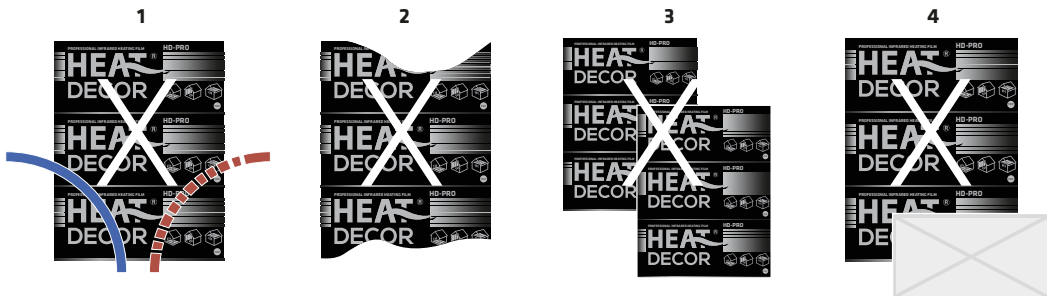

- 1. Arrangement of electric wires supplying the heating film above and under the heating film.
- 2. Cutting the film in places not designated for that.
- 3. Placing the film overlapped.
- 4. Placing the heating film under permanent furniture (fridge, washing machine, chest of drawers).

**! ATTENTION! DO NOT PLACE THE HEATING FOIL UNDER PERMANENT FURNITURE WITHOUT LEGS OF MIN. 30 mm. (REFRIGERATOR, WASHING MACHINE, CHEST OF DRAWERS).**

# PROJECTION AND SECTIONS OF THE HEATING FILM

## • UNDER THE PANEL

1. Floor finish (panels)
2. 0.2 mm vapor barrier film
3. **Heat Decor heating film**
4. HD.IS.100/5 foam insulation mat or HD-XPS300 styrodur boards
5. 0.2 mm vapor barrier film
6. Floor (cement screed or structure made of OSB/MFP boards)

SCHEME NO. 3

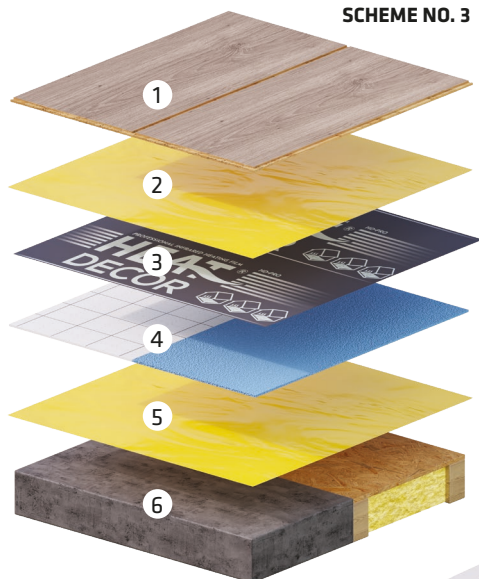

SCHEME NO. 4



SCHEME NO. 5

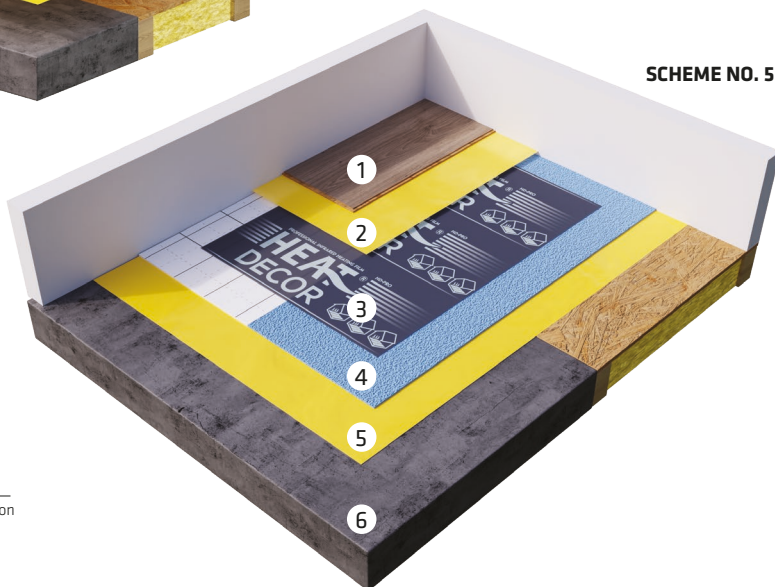

legend:

\*SCHEME NO. 3 : layers distribution

\*SCHEME NO. 4 : top view

\*SCHEME NO. 5 : side view

## EXAMPLE SCHEME OF THE HEATING FILM INSTALLATION

AIR TEMPERATURE SENSOR BUILT IN THERMOSTAT AND FLOOR TEMPERATURE SENSOR

SCHEME NO. 6

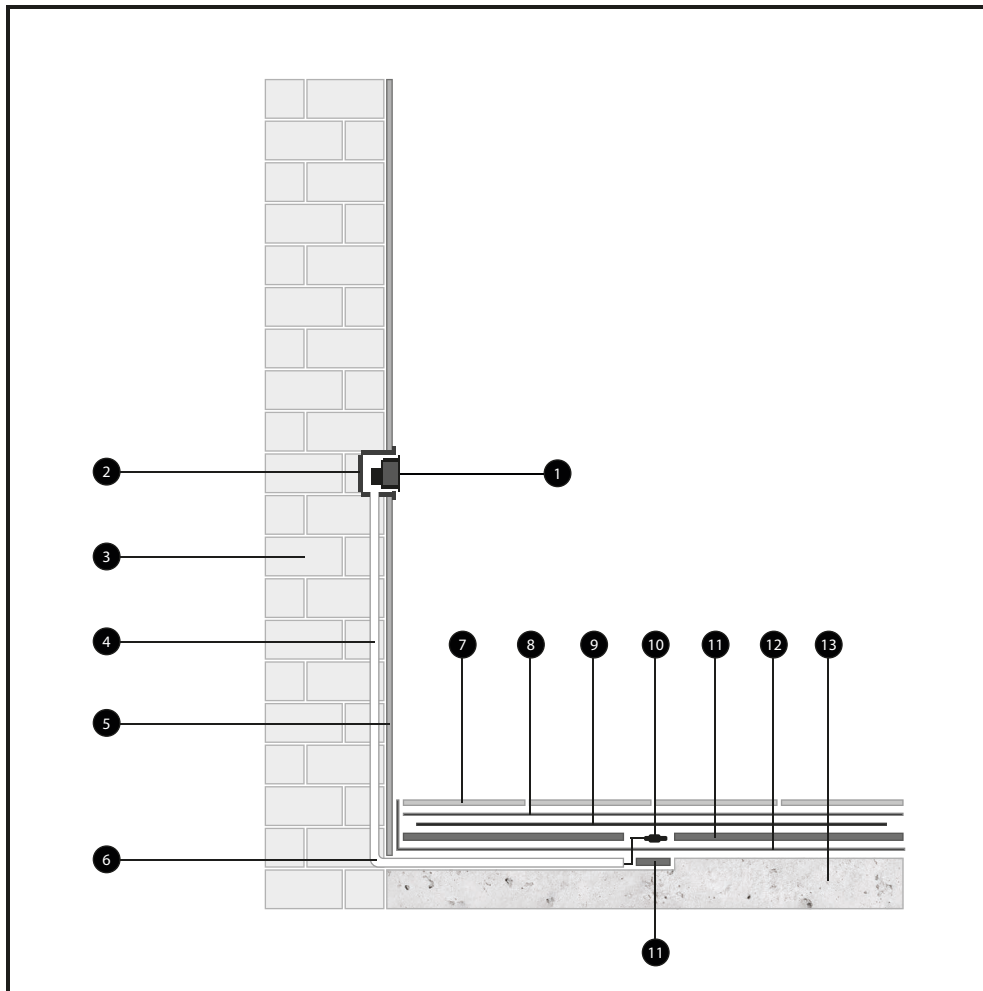

1. Thermostat
2. Installation box
3. Wall
4. A tube (conduit) with power wires from heating film
5. Plaster
6. Pipe (conduit) of the floor sensor
7. Floor panels

8. Vapor barrier film
9. **Heat Decor heating film**
10. Floor temperature sensor
11. Heat Decor insulating mat
12. Vapor barrier foil
13. Cement spout/OSB/MFP board structure

# ASSEMBLY MANUAL OF THE HD-PRO HEATING FILM UNDER THE PANELS

## PREPARING THE BOX AND THE PROTECTIVE CONDUIT FOR ELECTRICAL INSTALLATION

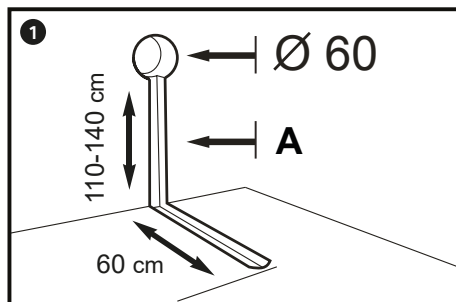

In the designated place, according to the design, use a drill or a hole saw to drill a hole for the Ø 60 electrical box. Carve an installation channel in the wall and the floor to accommodate two protective tubes (conduits) for the floor temperature sensor and the wires supplying the heating film. In place of the installation box, connect electric lines supplying heating film. The power cord cross-section is selected by a licensed electrician or designer.

A. Installation channel

**⚠ ATTENTION! PLACE THE INSTALLATION BOX DESIGNED FOR THE THERMOSTAT IN AN ACCESSIBLE PLACE, AND NOT EXPOSED TO THE SUN.**

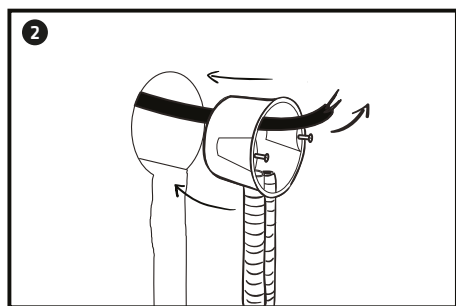

Insert the main power supply line and two protective conduits (to the floor temperature sensor, and for the wires supplying the heating film) into the installation box.

Cut the ends of the conduits to an appropriate length to accommodate the installation of the thermostat.

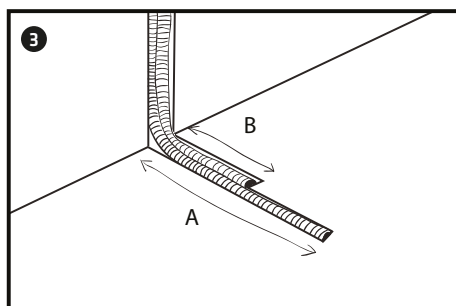

A. Floor temperature sensor conduit ~ 50 cm long. The floor temperature sensor must be placed under the heating film.

B. Conduit for heating film, length ~ 10 cm.

**⚠ ATTENTION! PROTECTIVE CONDUIT SHOULD BE PLACED IN PART OF THE FLOOR WHICH WILL NOT BE USED OFTEN AND NOT LOADED WITH FIXED ELEMENTS (WARDROBE, BED, ETC.) PROTECT THE SENSOR AGAINST ANY MECHANICAL DAMAGE (CRUSHING, CRUMPLING, ETC.).**

**⚠ ATTENTION! THE CONDUITS MUST BE INSTALLED UNDER THE HEATING FILM AND CANNOT PROTRUDE ABOVE THE FLOOR SURFACE. FAILURE TO COMPLY WITH THE ABOVE CONDITIONS RISKS OF FAILURE OF THE ENTIRE HEATING SYSTEM.**

**⚠ ATTENTION! THE END OF THE FLOOR TEMPERATURE SENSOR (A) MUST BE PLACED UNDER THE PLANNED HEATING FILM STRIPE (HEATING FIELD).**



## PREPARING THE BOX AND PROTECTIVE CONDUITS FOR ELECTRICAL INSTALLATION

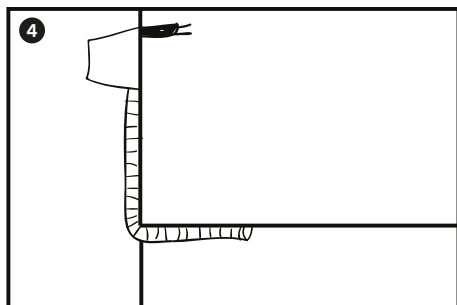

Protective conduits must not protrude above the level of the screed or the structure made of OSB/MFP boards.

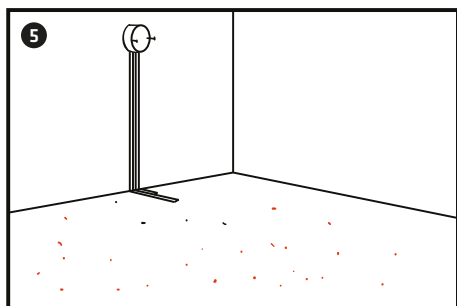

Installation channels should be cleaned of all impurities such as debris, dust, stones, and others.

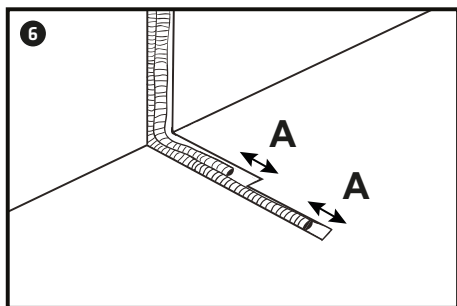

Attach the protective conduit to the floor with hot glue or adhesive mass in a way that prevents their movement. Leave free space at the end of the conduit to insert the floor temperature sensor and the wires supplying the heating film to the conduit.

**A.** Spacing of 2 cm.

## INSTALLATION OF THE FLOOR TEMPERATURE SENSOR

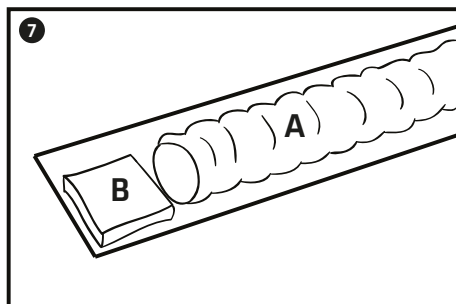

Check the position of the floor sensor protective conduit carefully. The conduit must not protrude above the floor surface. At the end of the conduit provided for the floor temperature sensor (NTC sensor), place a small square of an insulating mat.

**A** - protective conduit for the floor temperature sensor  
**B** - insulating mat

**⚠ ATTENTION! PROTECTIVE CONDUIT MAY NOT PROTRUDE OVER FLOOR SURFACE.**

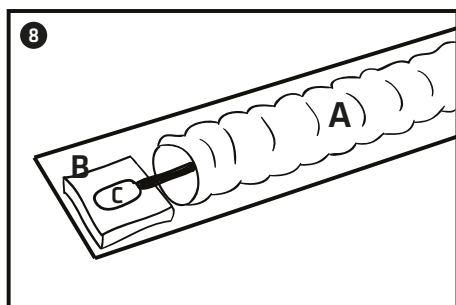

To the previously prepared conduit for the temperature sensor (**PIC. 6, PAGE 17**), (**SCHEM. 6, PAGE 15**) insert the temperature sensor. Place a small square of insulation mat at the end of the sensor (NTC sensor). The floor temperature sensor (NTC sensor) must not be placed directly on the concrete.

**A** - protective conduit for the floor temperature sensor  
**B** - insulating mat  
**C** - temperature sensor - NTC sensor

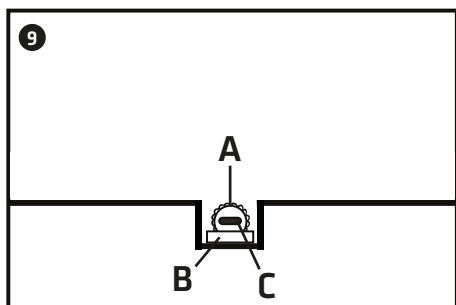

✓ Correctly placed protective conduit with the floor temperature sensor.

**A** - protective conduit for the floor temperature sensor  
**B** - insulating mat  
**C** - temperature sensor - NTC sensor

## PREPARING THE ROOM FOR INSTALLATION

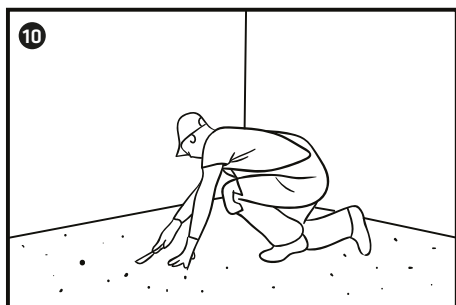

The floor surface must be free of all impurities and be even and stable. The residues of plaster, sharp elements, and unevenness should be removed with a spatula. The floor surface must be even and clean.

## PREPARING THE ROOM FOR INSTALLATION



Carefully and thoroughly clean the floor surface with vacuum cleaner.

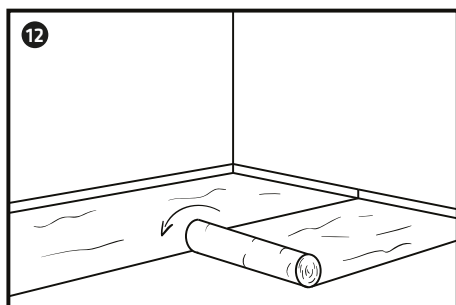

Place the vapor barrier film on the floor, folding it over the wall ~ 5 cm. Lay the vapor barrier film overlapping, minimum 10 cm. Place the vapor barrier film on the entire surface of the floor, even in places where the heating film will not be placed (the condition of anti-moisture insulation should be maintained).

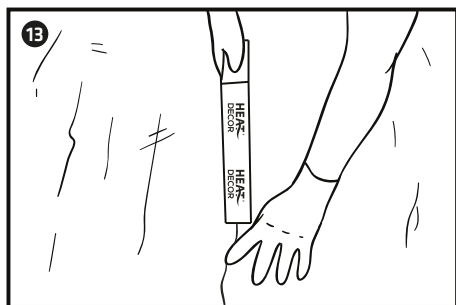

Connect the individual stripes of the vapor barrier film with an overlap of the adhesive tape.

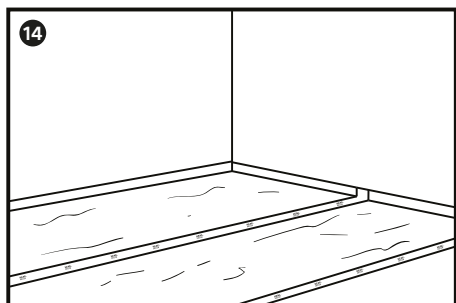

Carefully glue the vapor barrier film in place of connections with self-adhesive tape along its entire length. The vapor barrier film must be evenly distributed over its entire surface.

### FLOOR INSULATION HEAT DECOR HD.IS.100/5 BY FOAM INSULATION MAT

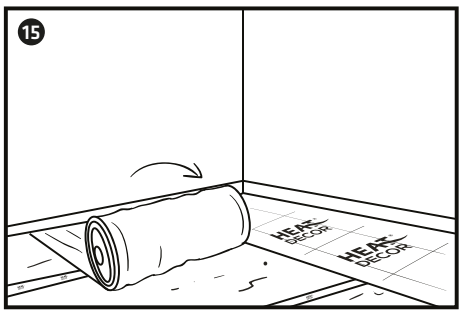

Place the Heat Decor insulating mat directly on the vapor barrier film. The Heat Decor insulating mat should be placed on the entire surface of the floor, even in places where the heating film will not be placed (maintaining the condition of thermal insulation). Cut the insulation mat properly at the corners.

**⚠ ATTENTION! HEAT DECOR HD.IS.100/5 FOAM INSULATION MAT ONLY USE UNDER FLOATING FLOORS MADE OF LAMINATE PANELS, WITH THICKNESS MIN. 6 mm.**

**⚠ ATTENTION! PLACE THE INSULATION MAT WITH THE COMPANY LOGO - HEAT DECOR - UP!**

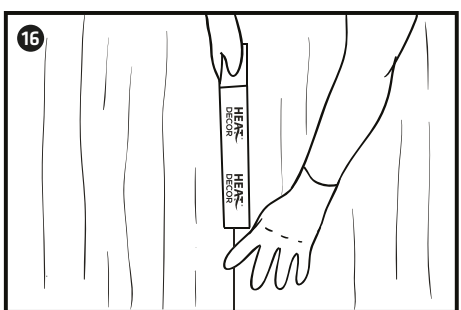

Glue the stripes of the insulating mat together with the Heat Decor adhesive tape at the connections.

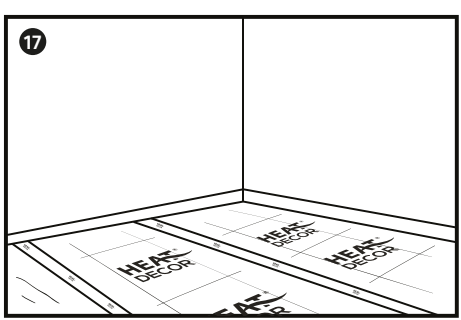

Stripes of the HD.IS.100/5 insulation mat at the edges should be glued together along its entire length. The HD.IS.100/5 insulating mat must be a stable base.

## FLOOR INSULATION HEAT DECOR HD-XPS300 PANEL INSULATION MAT

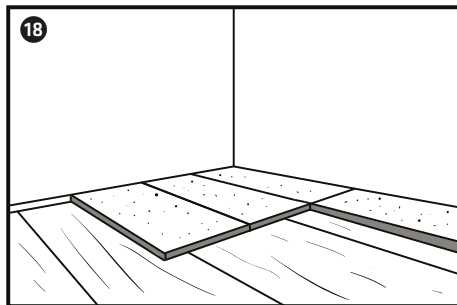

Place the HD-XPS300 insulation boards directly on the vapor barrier film. Place the HD-XPS300 boards over the entire floor surface, even in places where there will be no heating film (maintaining the condition of thermal insulation). Cut the insulation boards properly at the corners.

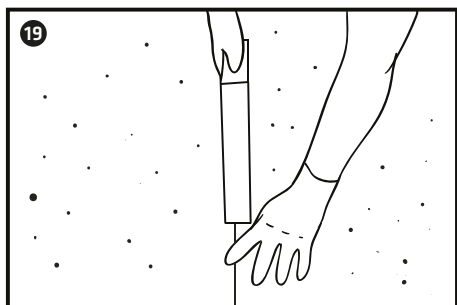

Glue the HD-XPS 300 insulation boards together with each other using a reinforced self-adhesive tape (model: T.HD.Z).

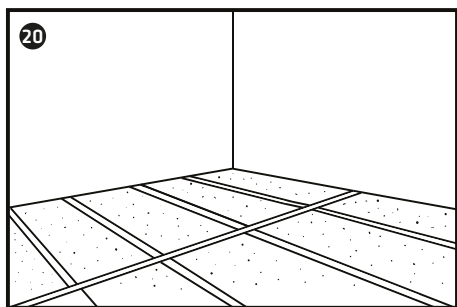

HD-XPS300 insulation boards in the place of connections should be connected with reinforced self-adhesive tape (model: T.HD.Z) along their entire length and width. HD-XPS300 insulation boards must be stable base.

## ARRANGING THE HEAT DECOR HEATING FILM

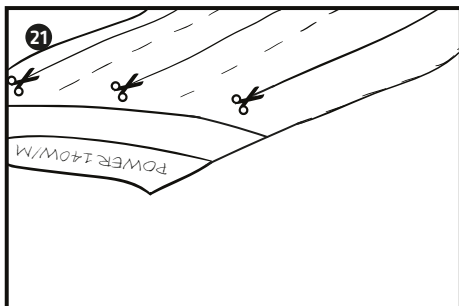

Before starting to unfold the heating film, check twice the compatibility of the heating power of the film with the planned electric installation.

The heating capacity of the film and its specifications can be found on the sidebar of the heating film.

## ARRANGING THE HEAT DECOR HEATING FILM

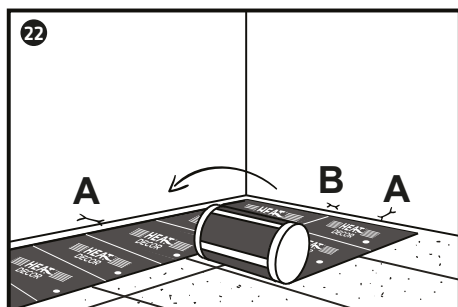

Unroll the Heat Decor heating film on the floor and cut it to the correct size in the area intended for this purpose. Arrange the heating film so that you can read the Heat Decor logo and inscription 'TOP'.

A. Distance from the wall min. 5 cm

B. The distance between the stripes of the Heat Decor heating film is 0.5 - 1 cm

**⚠ ATTENTION! BE CAREFUL NOT TO EXCEED THE MAXIMUM INSTALLATION LENGTH OF ONE STRIPE OF FILM (TAB. NO. 1, P. NO. 2).**

**⚠ ATTENTION! PLACE THE HEATING FILM ON THE FLOOR ON THE SITE WITH THE HEAT DECOR LOGO AND INSCRIPTION 'TOP' UP, SO YOU COULD READ IT FREELY.**

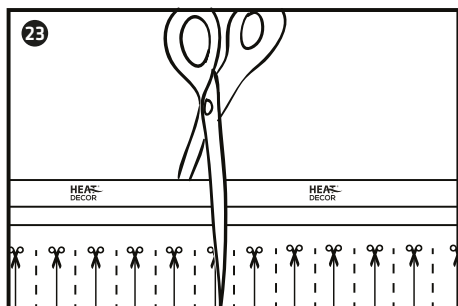

Cut the heating film only in a designated place. The cutting site is marked with a dotted line and a scissors symbol. Cut the film carefully and with due care to cut exactly along the dashed line.

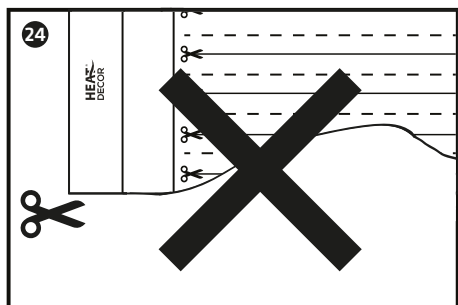

**⚠ ATTENTION! IN THE CASE OF A CUT IN THE PLACE OF THE CARBON MATRIX, THE HEATING FILM SHOULD BE CUTTED AGAIN CORRECTLY ON THE MARKED CUT LINE IN ANOTHER SECTION OF THE HEATING FILM.**

**⚠ ATTENTION! THE HEATING FILM CANNOT BE CUT IN THE PLACE OF THE CARBON MATRIX (BLACK FIELD). THE HEATING FILM SHOULD BE CUT ONLY IN A PLACE DESIGNATED CUTTING PLACE, MARKED WITH A DOTTED LINE AND THE SYMBOL OF SCISSORS.**

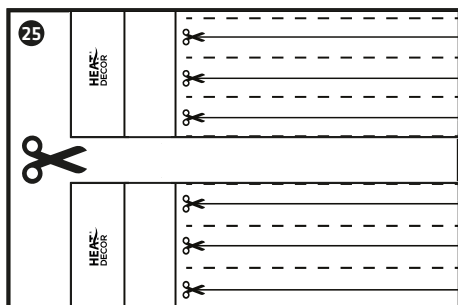

✓ Properly cut Heat Decor heating film.

## ARRANGING THE HEAT DECOR HEATING FILM



It is forbidden to put the heating film overlapped.  
It is forbidden to put the heating film on top of each other.

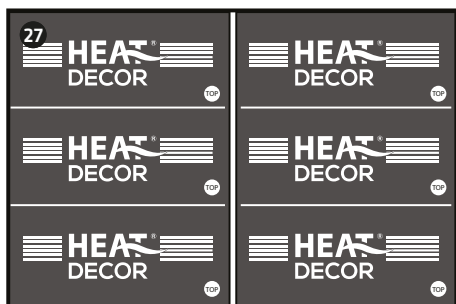

✓ Properly placed Heat Decor heating film.

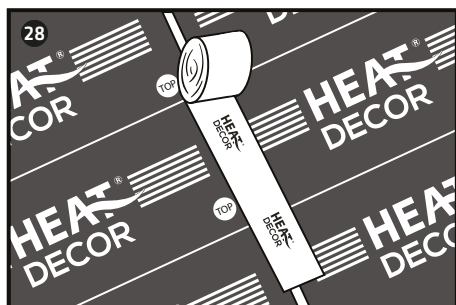

Attach the heating film stripes to the insulating mat with the Heat Decor adhesive tape.

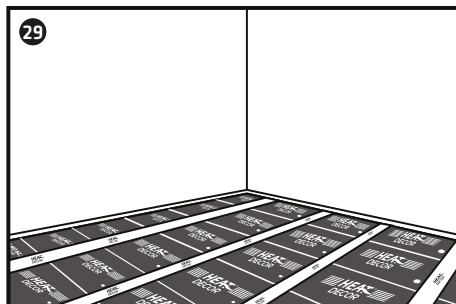

Attach the stripes of the heating film to the insulating mat along its entire length so that the heating film is stable and does not move.

## THE ELECTRICAL CONNECTION OF THE HEATING FILM

**⚠ ATTENTION! ELECTRICAL CONNECTIONS OF THE HEATING FILM CAN ONLY BE CARRIED OUT BY AN AUTHORIZED ELECTRICIAN. PERFORM THE ELECTRICAL CONNECTIONS CAREFULLY AND PRECISELY!**

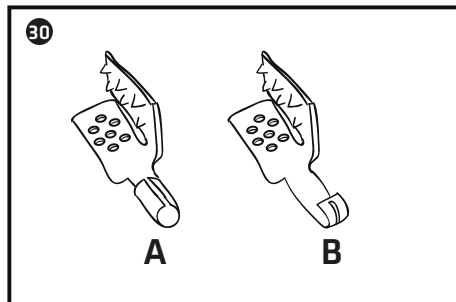

**A** - Connector type Ax, used for the electrical connection of the heating film with an electric wire in a straight system, where the wires exit along with the connector.

**B** - Connector type Bx, used for electrical connection of the heating film with an electric wire in an angle system, where the wire exits across the connector.

The connectors have tabs/teeth on one side, used to tighten the copper strip in the pocket of the heating film. Connectors should only be crimped with the HD-LS.02 clamping pliers, as the use of other tools may result in inaccurate crimping and damage.

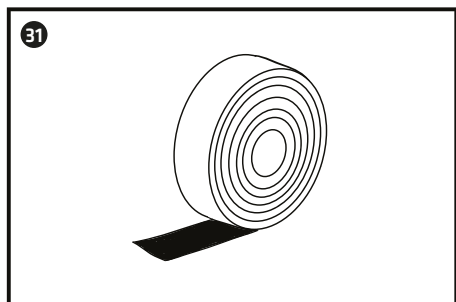

Self-amalgamating butyl tape, used to insulate electrical connections and the copper stripe of Heat Decor heating film.

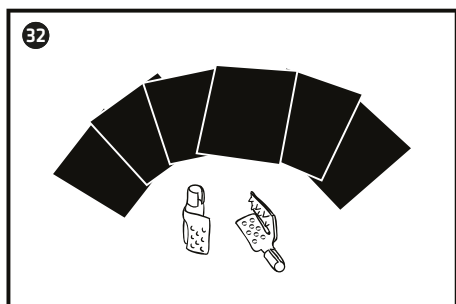

Connection set with connector type: Ax.

The set is used to electrically connect one stripe of Heat Decor heating film.

The composition of the set:

1. Two connectors, type: Ax.
2. Six sections of self-amalgamating tape.

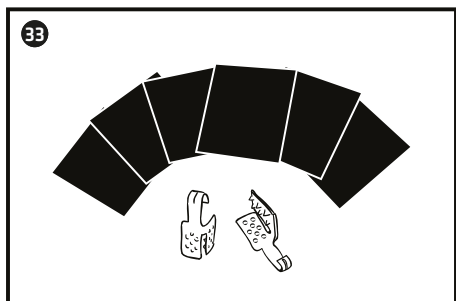

Connection set with connector type: Bx.

The set is used to electrically connect one stripe of Heat Decor heating film.

The composition of the set:

1. Two connectors, type: Bx.
2. Six sections of self-amalgamating tape.



## MAKING THE ELECTRICAL CONNECTION OF THE HEATING FILM

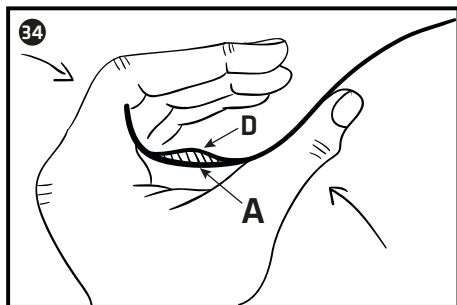

In the place where the copper stripe is located, gently bend the heating film in your hand so that the heating film installation pocket (A) opens.

- A - Heating film installation pocket
- D - Copper strip of heating film

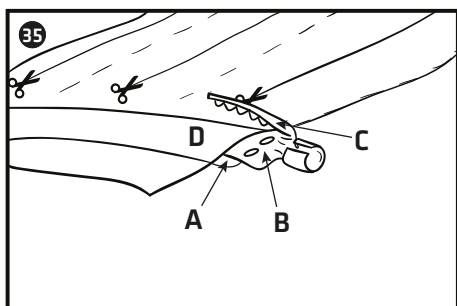

Insert the flat side of the connector (B) into the installation pocket of the heating film (A) so that the upper part of the connector (C) with the teeth crimp on the copper stripe (D).

The location of the copper stripe (D) on the Heat Decor HD-PRO heating film is mapped on the side edges of the silver side of the film with two continuous lines.

- A - Heating film installation pocket
- B - Flat side of the connector with holes
- C - The upper part of the connector with clamping teeth
- D - A copper stripe of heating film (mapped with two contiguous lines on the silver side of the film).

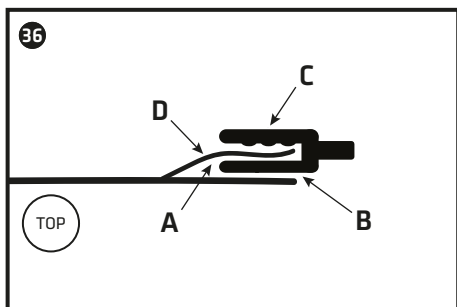

✓ Properly placed connector.

The connector is located in the installation pocket of the heating film (A) and clamps the copper stripe (D) with the clamping teeth of the connector (C).

- A - Heating film installation pocket
- B - Flat side of the connector with holes
- C - The upper part of the connector with clamping teeth
- D - A copper stripe of heating film (mapped with two contiguous lines on the silver side of the film).

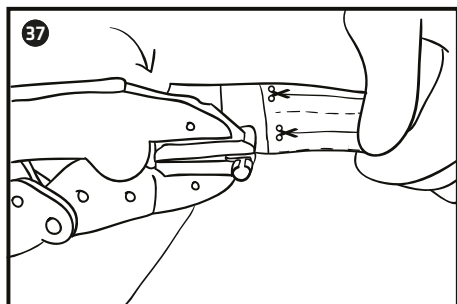

Crimp the connector securely in the center of the copper stripe of the heating film with the HD-LS.02 clamping pliers. Crimp the connector firmly and carefully so that the connector pierced into the copper surface.

## ELECTRICAL CONNECTION OF THE HEATING FILM

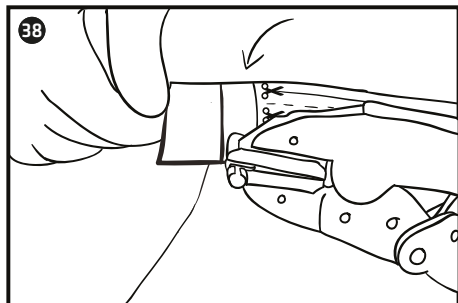

Perform the procedure of crimping the connector on the copper stripe of the heating film again on the other side of the connector. The connector must be pressed firmly and carefully on the copper stripe.

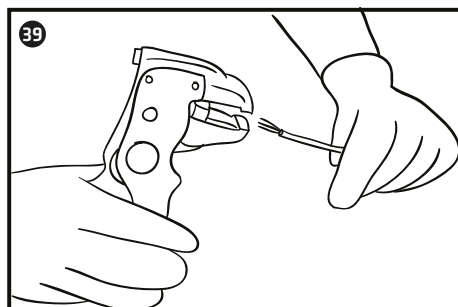

Strip the double insulation from the electric wire with stripping pliers (**PIC. 4 PAGE No. 6**).

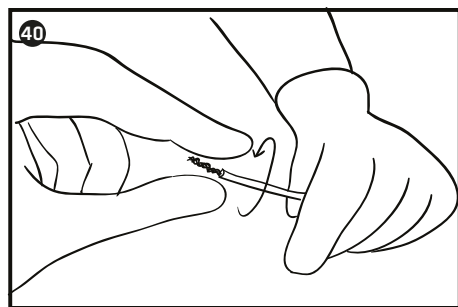

Twist the copper wires of the electric cable tightly to make it constituted a compact whole.

**ELECTRICAL CONNECTION WITH A CONNECTOR TYPE: Ax**

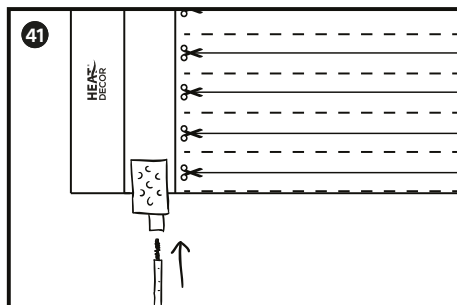

**Connector type: Ax**

Place the electric wire inside the connector. The copper wire of the electric cable must be placed inside the connector ensuring the correct electrical connection.

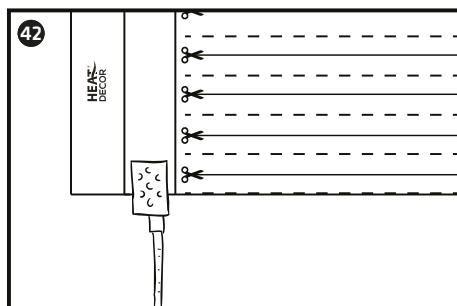

**Connector type: Ax**

✓ Properly placed electric wire in the Ax-type connector.

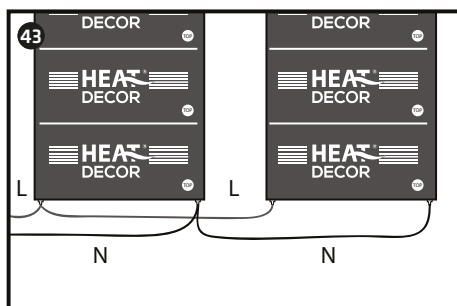

**Connector type: Ax**

If you connect the heating film stripes in parallel, place two electric wires in the connector and follow the shown wiring diagram.

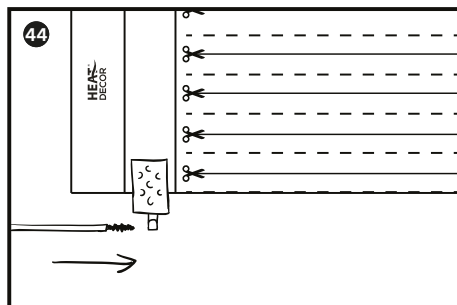
**ELECTRICAL CONNECTION WITH A CONNECTOR TYPE: Bx****Connector type: Bx**

Place the electric wire inside the connector. The copper wire of the electric cable must be placed in the connector ensuring proper electrical connection.

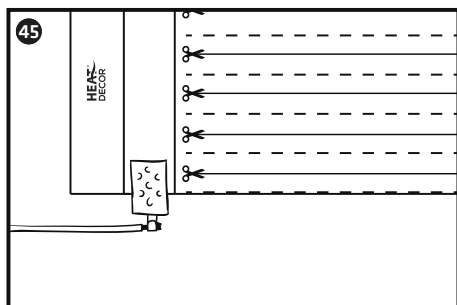
**Connector type: Bx**

✓ Properly placed electric wire in the Bx-type connector.

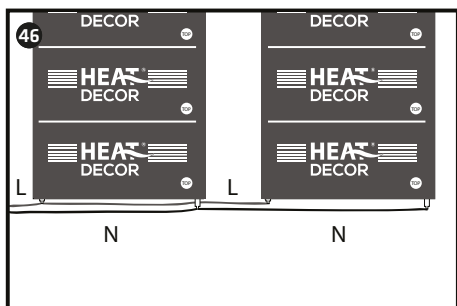
**Connector type: Bx**

If you connect the heating film stripes in parallel, the electric wire should go from one heating film stripe to the next heating film stripe continuously, without breaking the electric wire. Pull off the insulation of the electric wire with special pliers (PIC. 4, P. No. 6).

Follow the electrical wiring diagram shown.

## PERFORMING THE ELECTRICAL CONNECTION OF THE HEATING FILM

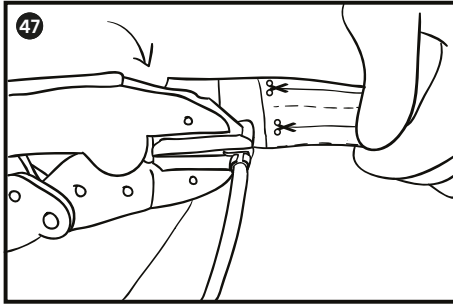

✔ Use the clamping pliers HD-LS.02 to tighten correctly inserted electric wire in the connector. The connection must be strong and durable.

**⚠ ATTENTION! TO STRENGTHEN THE ELECTRICAL CONNECTION PERFORM CRIMPING ON THE ENTIRE SURFACE OF THE CONNECTOR.**

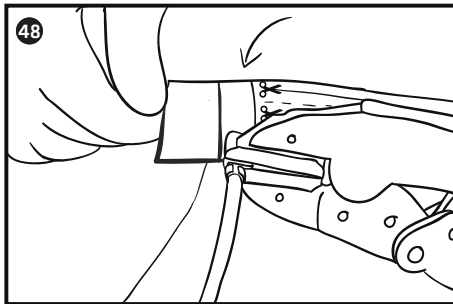

✔ Correctly placed electric wire.

Operate crimping the electric wire in the connector again on the other side of the connector. The connection must be strong and durable.

**⚠ ATTENTION! TO STRENGTHEN THE ELECTRICAL CONNECTION PERFORM CRIMPING ON THE ENTIRE SURFACE OF THE CONNECTOR.**

## CHECK THE ELECTRICAL CONNECTIONS OF THE HEATING FILM DOUBLE TO AVOID INSTALLATION ERRORS

**⚠ ATTENTION! ELECTRICAL CONNECTIONS OF THE HEATING FILM CAN ONLY BE CARRIED OUT BY A AUTHORIZED ELECTRICIAN. PERFORM THE ELECTRICAL CONNECTIONS CAREFULLY AND PRECISELY!**

**⚠ ATTENTION! THE COPPER WIRE OF THE ELECTRICAL CABLE MUST BE PLACED IN THE CONNECTOR ENSURING THE CORRECT ELECTRICAL CONNECTION.**

**⚠ ATTENTION! THE CONNECTOR AND THE WIRE MUST BE FITTED IN THE CENTER OF THE COPPER STRIPE. THE CONNECTION MUST BE STRONG AND DURABLE.**

**⚠ ATTENTION! TO STRENGTHEN THE ELECTRICAL CONNECTION PERFORM CRIMPING ON THE ENTIRE SURFACE OF THE CONNECTOR.**

## ELECTRICAL INSULATION OF HEAT DECOR HEATING FILM

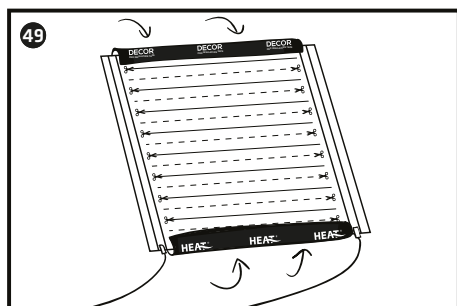

At both cut ends of the heating film, perform electrical insulation with dedicated black insulation tape Heat Decor HD-PRO.

Insulate the cutting area of the heating foil in the section between the two copper stripes.

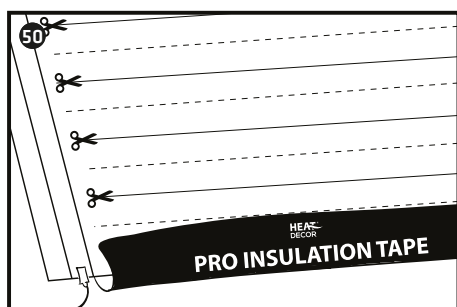

The HD-PRO insulation tape must be stucked symmetrically on both sides of the heating film.

**⚠ ATTENTION! INSULATE BOTH ENDS OF THE HEATING FILM STRIPE WITH HD-PRO INSULATION TAPE BETWEEN INSTALLATION CONNECTORS. THE COPPER STRIPES AND THE CONNECTORS WILL BE INSULATED IN THE NEXT STAGE WITH SELF-AMALGAMATING TAPE.**

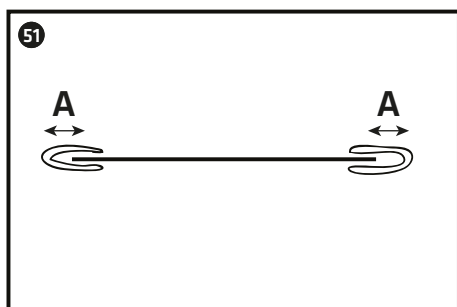

✓ Properly insulated stripe of heating film in cutting areas with the Heat Decor HD-PRO black insulating tape.

The insulating tape must not be attached directly to the edges of the heating film.

**A** - The allowance width of the insulating tape from the edges of the heating film, min. 3-7 mm.

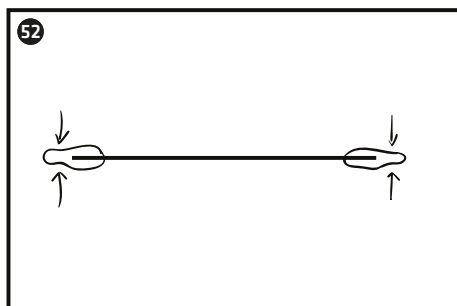

✓ Properly insulated stripe of heating film in cutting areas with the Heat Decor HD-PRO black insulating tape.

Sticked Heat Decor HD-PRO black insulating tape, press down carefully and precisely.

## ELECTRICAL INSULATION OF HEAT DECOR HEATING FILM

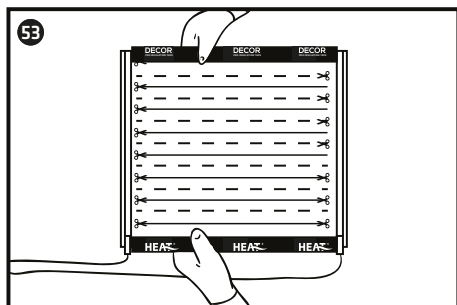

Repeat the operation of pressing the HD-PRO insulation tape on both sides of the heating film stripe. Perform this operation carefully and precisely.

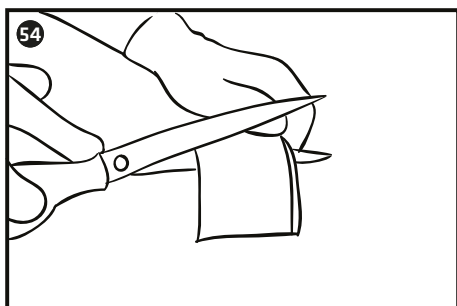

Cut the self-amalgamating tape to the correct size to cover the entire electrical connection area. The minimum size of the self-amalgamating tape is 6 cm x 5 cm.

**! ATTENTION! IF YOU HAVE PURCHASED A HEATING FILM KIT, USE A PREPARED SELF-AMALGAMATING TAPE FROM TYPE AX OR TYPE BX KIT (PIC. 30, 31 P. NO. 24).**

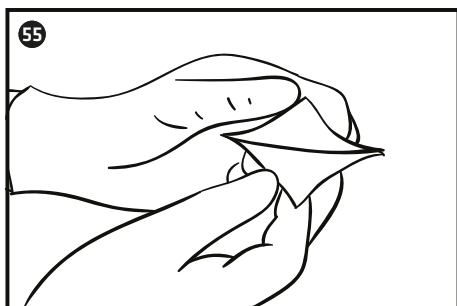

Remove the protective paper from the self-amalgamating tape

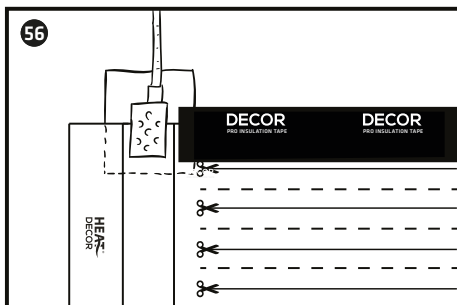

Stick the self-amalgamating tape to the heating film in the place where the connector connects with the copper stripe.

The self-amalgamating tape must cover the entire surface of the connector, the copper stripe and the HD-PRO insulation tape with an allowance.

**! ATTENTION! CAREFULLY INSULATING THE ELECTRICAL CONNECTION. THE SELF-AMALGAMATING TAPE MUST COVER THE ENTIRE SURFACE OF THE CONNECTOR, THE COPPER STRIPE, AND THE HD-PRO INSULATING TAPE.**

## ELECTRICAL INSULATION OF HEAT DECOR HEATING FILM

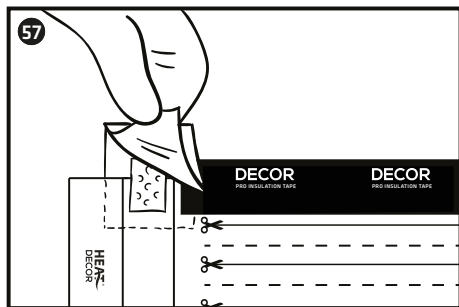

Carefully stick the second self-amalgamating tape on the other side of the connector to cover the entire surface of the connector, the copper stripe, and part of the HD-PRO insulation tape.

Place the second self-amalgamating tape symmetrically to the first one.

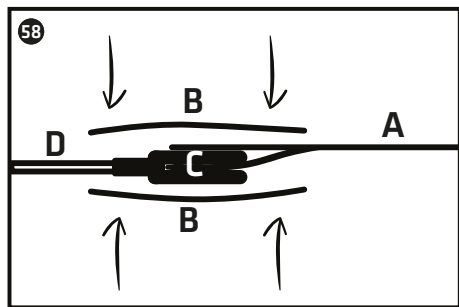

✓ Properly positioned self-amalgamating tapes on both sides of the electrical connector.

- A - Heat Decor heating film
- B - self-amalgamating butyl tape
- C - Ax type installation connector
- D - electric wire with double insulation (cable)

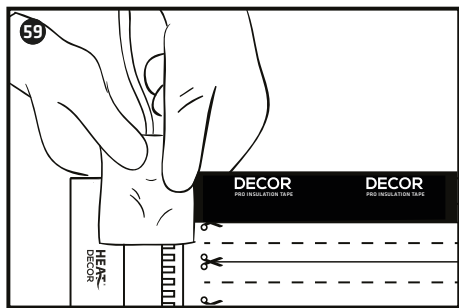

Use your fingers to press down carefully and firmly the correctly positioned self-amalgamating tapes. Self-amalgamating tapes should be joined together.

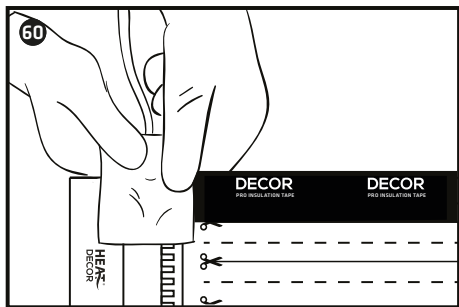

Repeat the procedure of tightening the self-amalgamating tape several times. Self-amalgamating tapes must be tightened carefully and firmly over their entire surface.



## ELECTRICAL INSULATION OF HEAT DECOR HEATING FILM

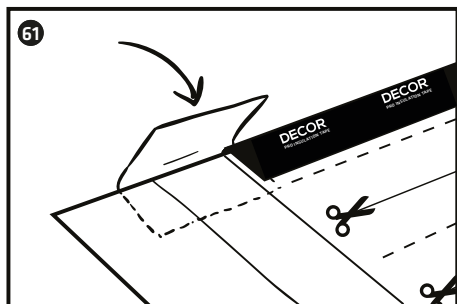

Insulate the copper tape with self-amalgamating tape on the opposite end of the heating film stripe. Glue the self-amalgamating tape section min. dimensions 5x6 cm to the heating film from the bottom, leaving the top part of the self-amalgamating tape to the fold.

The self-amalgamating tape must cover the copper stripe and part of the HD-PRO insulation tape with an allowance.

**⚠ ATTENTION! CAREFULLY INSULATING THE ELECTRICAL CONNECTION. THE SELF-AMALGAMATING TAPE MUST COVER THE ENTIRE SURFACE OF THE COPPER STRIPE AND PART OF THE HD-PRO INSULATION TAPE WITH AN ALLOWANCE.**

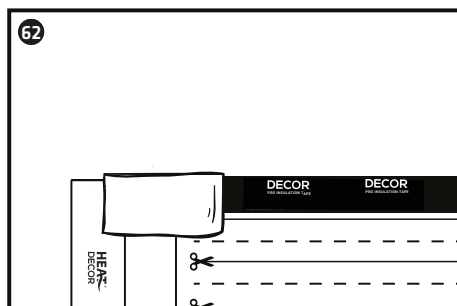

Fold the second part of the self-amalgamating tape on the heating film carefully and symmetrically.

The self-amalgamating tape must cover the copper stripe and part of the HD-PRO insulating tape with an allowance.

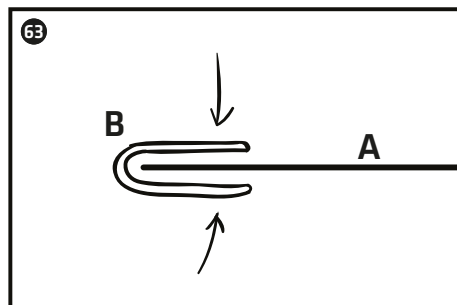

✓ Correctly placed self-amalgamating tape in the place of cutting the heating film.

Self-amalgamating tape is stuck on both sides of the heating film.

**A** - Heat Decor heating film

**B** - self-amalgamating butyl tape

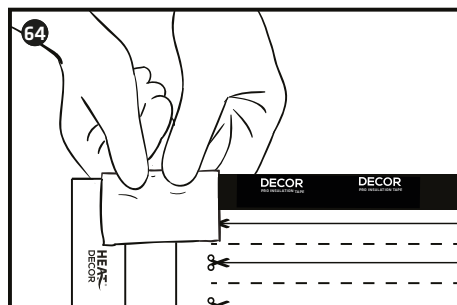

✓ Use your fingers to press down carefully and firmly the correctly positioned self-amalgamating tapes. Self-amalgamating tapes should be joined together.

## ELECTRICAL INSULATION OF HEAT DECOR HEATING FILM

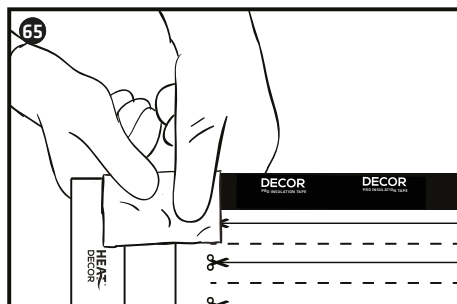

Repeat the procedure of tightening the self-amalgamating tape several times. Self-amalgamating tapes must be tightened carefully and firmly over their entire surface.

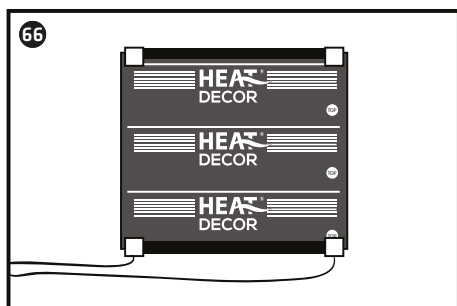

✓ A properly insulated heating film with a type Ax connector. Self-amalgamating tape on both sides of the heating film.

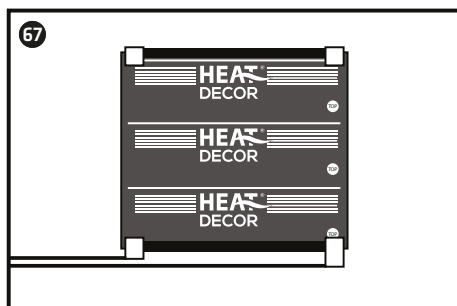

✓ A properly insulated heating film with a type Bx connector. Self-amalgamating tape on both sides of the heating film.

## DOUBLE CHECK THE INSULATION OF THE HEATING FILM ELECTRICAL CONNECTIONS TO AVOID INSTALLATION ERRORS

**!** ATTENTION! CAREFULLY INSULATE THE ELECTRICAL CONNECTION AND THE EDGE OF THE HEATING FILM. THE HD-PRO INSULATING TAPE MUST BE STICKED ON THE ENTIRE EDGE OF THE HEATING FILM AT ITS CUT, ON BOTH SIDES OF THE HEATING FILM.

**!** ATTENTION! THE HEATING FILM SHOULD BE INSULATED ON BOTH SIDES. INSULATE THE HEATING FILM CAREFULLY IN THE PLACE OF THE ELECTRICAL CONNECTION WITH SELF-AMALGAMATING TAPE, AND ON THE OPPOSITE SIDE IN THE PLACE OF CUT THE HEATING FILM.

**!** ATTENTION! ELECTRICAL CONNECTIONS AND INSULATION OF THE HEATING FILM CAN ONLY BE PERFORMED BY A CERTIFIED ELECTRICIAN. MAKE THE ELECTRICAL CONNECTIONS CAREFULLY AND PRECISELY!

## PLACING THE HEATING FILM ABOVE THE FLOOR TEMPERATURE SENSOR

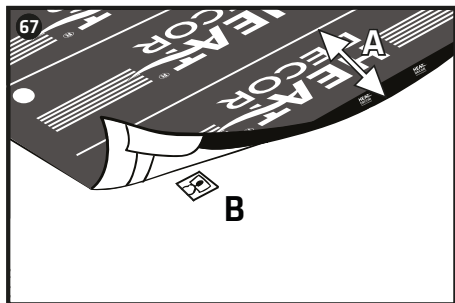

Gently cut a hole in the insulating mat for the floor temperature sensor (NTC sensor).

Check if the temperature sensor (NTC sensor) is exactly in the place of the heating field (carbon).

**A** - heating area

**B** - floor temperature sensor

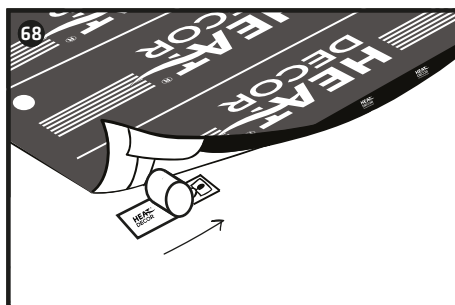

Close the hole in the insulating mat at the sensor site with adhesive tape.

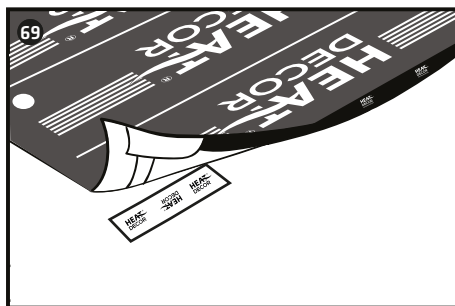

✓ Properly tape-protected floor temperature sensor (NTC sensor).

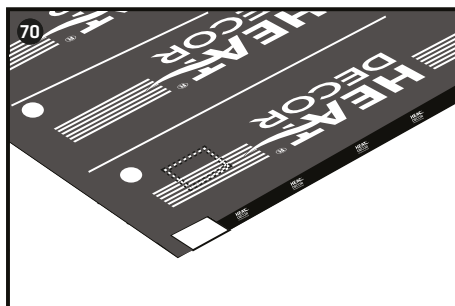

Cover the heating film with the tape-protected floor temperature sensor (NTC sensor).

The floor temperature sensor (NTC sensor) must be in place of the heating zone (carbon).

## INSTALLATION OF THE HEAT DECOR HEATING FILM ON THE INSULATION MAT

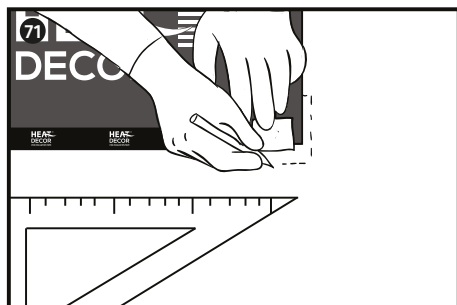

The surface of the heating film placed on the insulating mat must be flat, with no protruding parts. The connectors of the heating film and electric wires supplying the heating film must not be above the surface of the heating film.

To maintain a flat surface condition, all elements protruding above the surface of the heating film should be placed in previously prepared holes in the insulating mat.

Use a felt-tip pen to outline the connectors and the routes of electric wires.

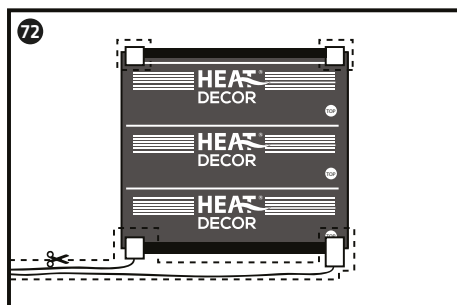

Use scissors to cut the marked holes in the insulating mat. All connecting elements and electric wires supplying the heating film must be placed in the prepared holes so that they do not protrude above the heating film surfaces.

**⚠ ATTENTION! WHILE CUTTING OUT THE HOLES, BE CAREFUL NOT TO DAMAGE THE VAPOR INSULATION FILM UNDER THE INSULATION MAT!**

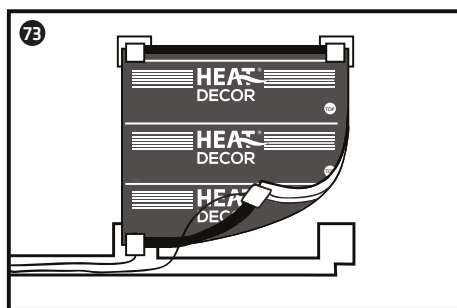

Check the location of the holes in the insulating mat carefully and make sure that all connectors and electrical wires are below the surface of the Heat Decor heating film.

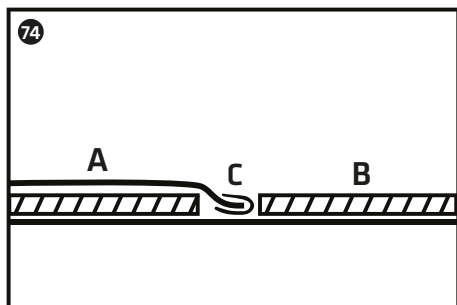

☑ Properly placed heating film with an insulating joint in the prepared hole in the insulating mat. The insulated joint is located below the surface of the heating film.

- A - Heat Decor heating film
- B - Heat Decor insulating mat
- C - insulated joint of the heating film

## INSTALLATION OF THE HEAT DECOR HEATING FILM ON THE INSULATION MAT

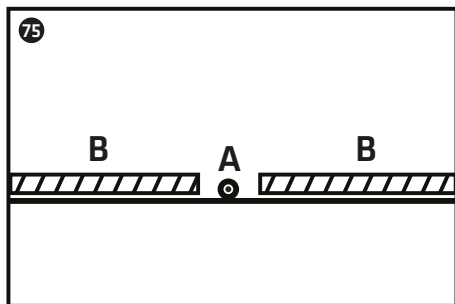

✓ Correctly positioned power cord (wire) in the insulating mat. The power cord is below the surface of the heating film.

**A** - power cord (wire)

**B** - insulating mat

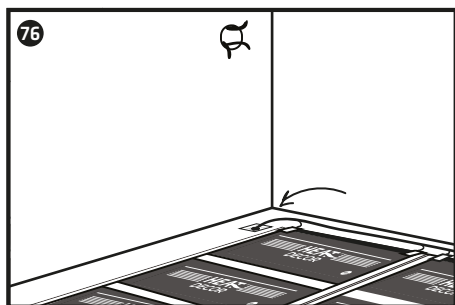

Cut a hole in the insulating mat in place of the protective conduit designed for the wires supplying the heating film.

Insert the wires supplying the heating film to the protective conduit and lead them out in the installation box.

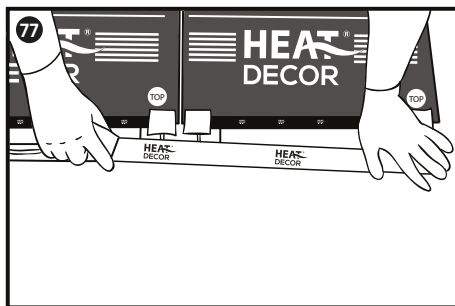

lose insulated electrical connections and electrical wires placed in cut openings with adhesive tape. All elements in the holes of the insulating mat must be carefully glued with adhesive tape.

**!** ATTENTION! WHEN USING THE HD-XPS300 INSULATING MAT, APPLY ADHESIVE REINFORCED TAPE T.HD.Z.

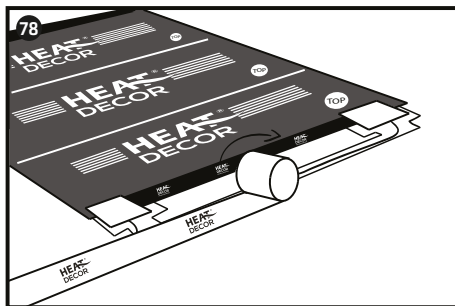

With successive sections of the adhesive tape carefully cover the heating film and the insulated electrical connections. Do this carefully and precisely.

**INSTALLATION OF THE HEAT DECOR HEATING FILM ON THE INSULATION MAT**

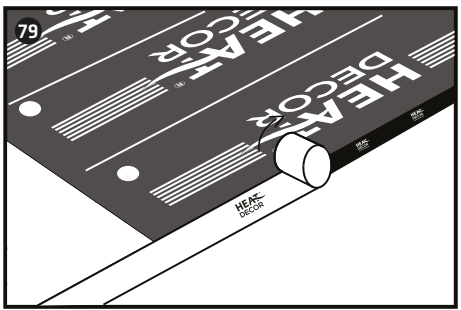

Carefully stick the adhesive tape on the other end of the heating film stripe on the insulated electrical connections.

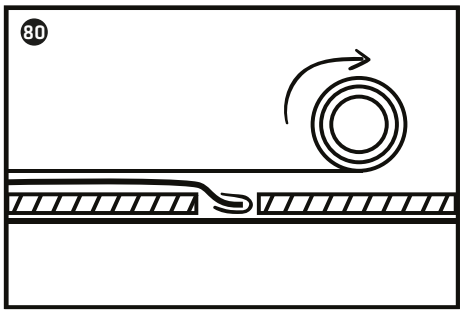

✓ Properly glued adhesive tape on heating film with an insulated electrical connector.

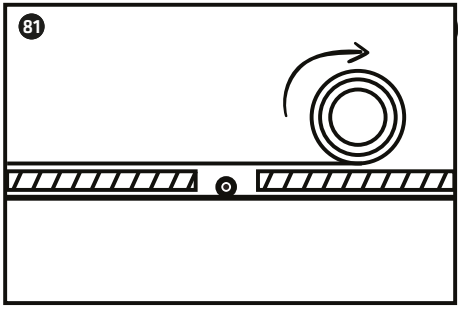

✓ Electric wire (cable) properly sealed with adhesive tape.

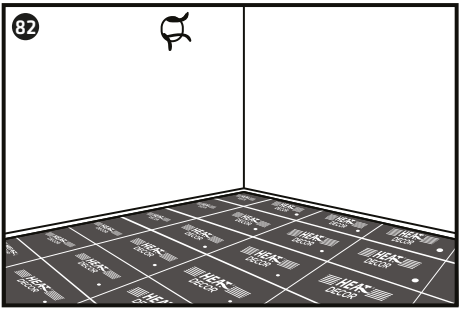

Check carefully whether the heating film is placed correctly, following the instructions in the manual. Make sure that the surface of the heating film is clean, stable, and flat (no protruding parts).

## HEATING INSTALLATION MEASUREMENT AND TEST

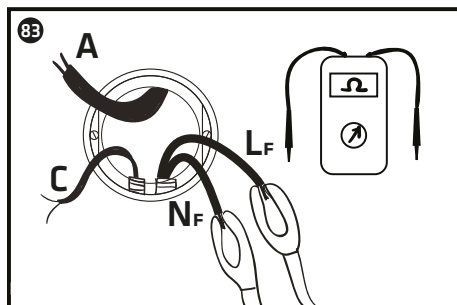

To check the continuity of electrical connections and the installed heating film, measure the resistance of the installed heating film.

Write down the resistance measurement result in the warranty card. Calculate the power of the installed heating film based on the formula below and write the result in the warranty card.

$$\text{POWER [W]} = \frac{\text{voltage (V)}^2}{\text{resistance } (\Omega)}$$

- L<sub>F</sub> - phase electric wire of the heating film
- N<sub>F</sub> - neutral electric wire of the heating film
- A - power cord
- C - floor temperature sensor cable

**⚠ ATTENTION: IF THE INSTALLATION POWER OF THE HEATING FILM EXCEEDS 80% OF THE MAXIMUM POWER LOAD VALUE OF THE GIVEN TEMPERATURE REGULATOR (THERMOSTAT) USE A CONTACTOR OR A SECOND THERMOSTAT!**

**⚠ ATTENTION: IF THE RESISTANCE MEASUREMENT RESULT AND THE CALCULATED POWER IS INCOMPATIBLE WITH THE NOMINAL POWER OF THE HEATING FILM (+/- 10%) THE HEATING FILM HAS BEEN INSTALLED INCORRECTLY AND IS NOT SUITABLE FOR OPERATION. CHECK THAT THE HEATING FILMS HAVE THE SAME RATING POWER.**

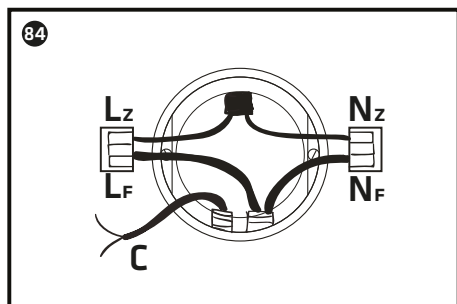

Perform a test of the heating film installation by connecting it to the power supply. Perform the connection of the heating film with the power supply according to the diagram.

- L<sub>z</sub> - phase network electric wire
- L<sub>f</sub> - phase electric wire of the heating film
- N<sub>z</sub> - neutral electric wire
- N<sub>f</sub> - neutral electric wire of the heating film
- C - floor temperature sensor cable

**⚠ ATTENTION! ELECTRICAL CONNECTIONS OF THE HEATING FILM CAN ONLY BE CARRIED OUT BY A AUTHORIZED ELECTRICIAN. MAKE THE ELECTRICAL CONNECTIONS CAREFULLY AND PRECISELY!**

**⚠ ATTENTION! BEFORE TURNING ON THE HEATING INSTALLATION, CAREFULLY CHECK THE CONNECTION OF THE ELECTRICAL WIRES AND THE ELECTRICAL CIRCUITS OF THE HEATING FILM.**

## HEATING INSTALLATION MEASUREMENT AND TEST

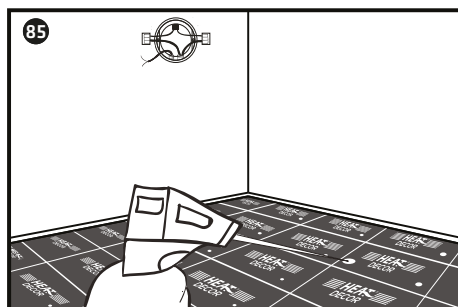

After connecting the heating film to the electric mains, measure the temperature of the heating film.

Using an electronic device (pyrometer, thermal imaging camera) or by touching the film with your hand, check whether the heating film heats up on all installed heating stripes and zones.

After the heating system test is completed, disconnect the entire heating system of the power supply.

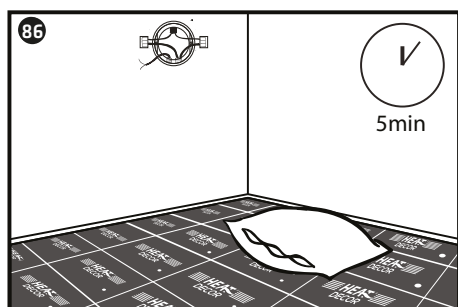

If it is not possible to measure the temperature of the heating film with an electronic device (pyrometer), check the temperature of the heating film with a pillow.

Place the pillow on the heating film and leave it for about 5 minutes. After this time, raise the pillow and check if the temperature on the surface of the film and pillow is higher.

After the heating system test is completed, disconnect the entire heating system from the power supply.

**⚠ ATTENTION! IF THE HEATING FILM DOES NOT HEAT UP, DISCONNECT THE ENTIRE INSTALLATION AND CAREFULLY CHECK ALL ELECTRICAL CONNECTIONS AND PROTECTIONS IN THE ELECTRICAL SWITCH CABINET.**

**⚠ ATTENTION! AT THE LOW RATING POWER OF HEATING FILM AS 60/80 [W/SQM], THE TEMPERATURE OF THE HEATING FILM RISES SIGNIFICANTLY AND MAY BE UNDETECTABLE TO THE TOUCH.**

**⚠ ATTENTION! AFTER PERFORMING THE HEATING INSTALLATION TEST, DISCONNECT THE ENTIRE HEATING SYSTEM FROM THE ELECTRICAL POWER SUPPLY.**

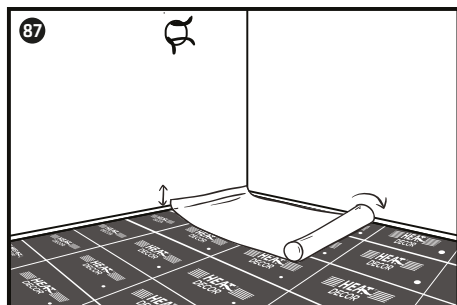

**FINISHING INSTALLATION OF THE HEATING FILM**

After checking the correct operation of the heating system, spread the vapor barrier film over the entire surface of the room using an overlap of min. 10 cm.

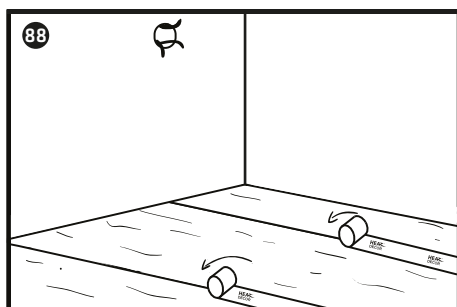

Carefully glue the vapor barrier film in place of connections with self-adhesive tape along its entire length. The vapor barrier film must be evenly distributed over its entire surface.

Connect the individual stripes of the vapor barrier film with overlap by the adhesive tape.

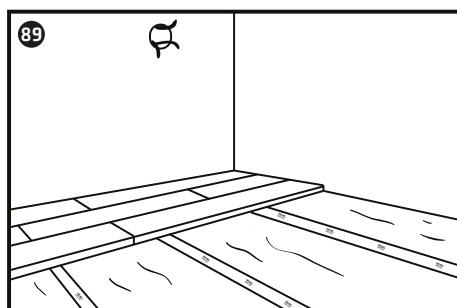

After laying and gluing the vapor barrier foil, arrange the floating floor panels.

**⚠ ATTENTION! WHEN INSTALLING FLOORING, WEAR ONLY SOFT AND FLAT FOOTWEAR.**

**⚠ ATTENTION! PLEASE PAY PARTICULAR ATTENTION WHEN LAYING THE FLOOR COVERING, SO IT DOES NOT DAMAGE THE VAPOR BARRIER FILM AND THE HEATING FILM.**

**⚠ ATTENTION! PLACE THE FLOOR COVERING ACCORDING TO THE MANUAL, CAREFULLY AND KEEPING CLEAN.**

**⚠ ATTENTION! DURING THE INSTALLATION OF THE FLOOR, IT IS FORBIDDEN TO LEAVE ANY DIRT ON THE SURFACE OF THE FILM. THIS CAN DAMAGE THE HEATING SYSTEM.**

**⚠ ATTENTION: NOT FOLLOWING TO THE MANUAL MAY CAUSE DAMAGE TO THE HEATING SYSTEM.**

## FINISHING INSTALLATION OF THE HEATING FILM

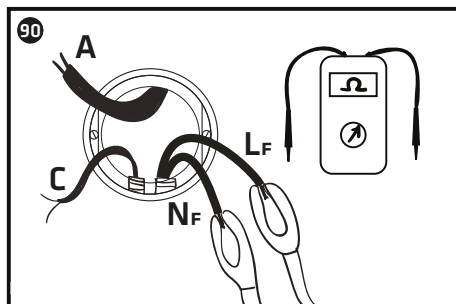

To check the installation of the heating film and continuity electrical connections, measure the installed resistance heating film.

Write down the resistance measurement result in the warranty card.

**Lf** - phase electric wire of the heating film  
**Nf** - neutral electric wire of the heating film  
**A** - power cord  
**C** - floor temperature sensor cable

**⚠ ATTENTION! IF THE RESISTANCE MEASUREMENT IS INCOMPATIBLE WITH THE EARLIER RESISTANCE MEASUREMENT, THE INSTALLATION HAS BEEN DAMAGED DURING THE FLOOR INSTALLATION. IN THIS CASE, IT IS FORBIDDEN TO USE THE HEATING SYSTEM.**

**⚠ ATTENTION: FOR THE ACCURACY OF THE MEASUREMENT INSTRUMENTS, TOLERANCES OF ERROR OF RESISTANCE MEASURED + -1%**

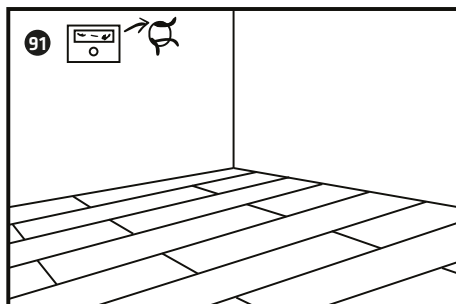

After measuring the heating film and confirming the correct operation of the heating system, install the thermostat (temperature regulator) following the original installation manual attached to the thermostat.

Once the thermostat has been correctly installed, check the heating system again.

Set the temperature limit of the floor temperature sensor according to the recommendations of the floor covering manufacturer. (The optimal floor temperature is ~ 28 °C)

Heat up the applied floor covering in accordance with the recommendations of the floor covering manufacturer.

**ATTENTION!**

**NOT FOLLOWING THE INSTRUCTIONS MAY BE THE CAUSE OF DAMAGE TO THE HEATING SYSTEM, DAMAGE TO HOUSEHOLD APPLIANCES, ELECTRICAL SHOCK, INJURY, OR DEATH.**

**Thank you for following the instructions and we wish you many peaceful years of energy-saving, green warmth!**

## SKETCH OF THE HEATING FILM INSTALLATION

### Drawing guidelines:

1. The outline of the room with dimensions
2. Stripes of heating films (distance from the walls)
3. Power of the heating film stripes
4. Thermostat
5. Location of the temperature sensor
6. The route of laying the electric wires

electrician's stamp and signature

## SKETCH OF THE HEATING FILM INSTALLATION

### Drawing guidelines:

1. The outline of the room with dimensions
2. Stripes of heating films (distance from the walls)
3. Power of the heating film stripes
4. Thermostat
5. Location of the temperature sensor
6. The route of laying the electric wires

electrician's stamp and signature

## SKETCH OF THE HEATING FILM INSTALLATION

### Drawing guidelines:

1. The outline of the room with dimensions
2. Stripes of heating films (distance from the walls)
3. Power of the heating film stripes
4. Thermostat
5. Location of the temperature sensor
6. The route of laying the electric wires

electrician's stamp and signature

## SKETCH OF THE HEATING FILM INSTALLATION

### Drawing guidelines:

1. The outline of the room with dimensions
2. Stripes of heating films (distance from the walls)
3. Power of the heating film stripes
4. Thermostat
5. Location of the temperature sensor
6. The route of laying the electric wires

electrician's stamp and signature

# WARRANTY CARD

**THE MANUFACTURER PROVIDES A 25-YEAR WARRANTY ON HEATING FILM  
FROM THE HD-PRO SERIES MODEL: HD-PRO.100, HD-PRO.50, HD-PRO.25**

## The warranty does not cover:

1. Mechanical damage to the heating film.
2. Damage to the heating film as a result of fire, flood, lightning strike.
3. Damage to the heating film resulting from the installation of the heating film not following the instructions contained or improper use.
4. Damage to the heating film or malfunction of the heating system resulting from the use of materials inconsistent with the manufacturer's recommendations and assembly instructions.

DATA	
Buyer	
Heating film installer (stamp)	
HEATING FILM INSTALLATION DATA	
Installation date	
Model & power of the heating film	
Type of heating film installation	
Heating power of the installation [W/sqm]	
Number of installed heating film [sqm]	
Measurement of the resistance of the heating film [ $\Omega$ ] (1)	
Measurement of the resistance of the heating film [ $\Omega$ ] (2)	

## Required attachments:

1. Sketch of heating film installation
2. Protocol of receipt of the heating film installation
3. Measurement report of the electric heating film installation
4. Proof of purchase of the heating film

# HEAT<sup>®</sup> DECOR

ALL RIGHTS RESERVED © HEAT DECOR SP. Z O.O.